

**SECTION A-A**

**SECTION B-B**

Silicone Washer

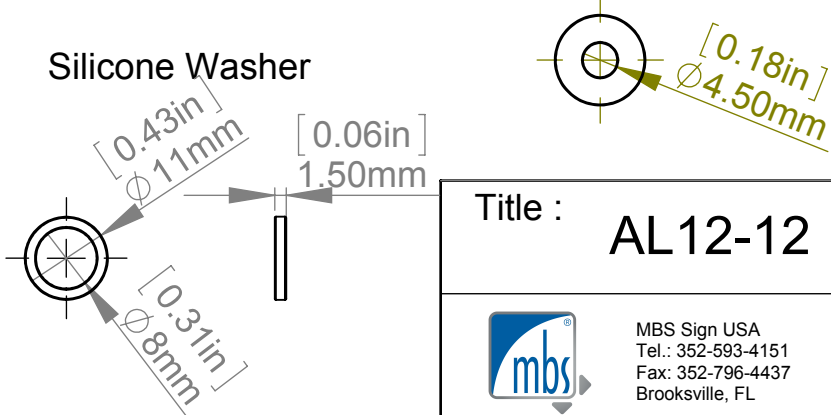

Item	Qty.	Description
1	1	AL12-12 Body (12x12)
2	1	AL12 Head
3	2	AL12 Washer

Title : <b>AL12-12</b>		Scale : 1:1		Mbs R&D	
Material:		Sizes : Letter Landscape		Customer:	
N°programme laser		Finish		Qty :	Rep :
N°prog. Mécanum.		N° Plan : AL12-12			



MBS Sign USA  
Tel.: 352-593-4151  
Fax: 352-796-4437  
Brooksville, FL